

BC-076
SPECIFICATION



Version History

Version	Description	Date
V1.0	Initial release.	March 28, 2016
V1.01	New Matrix 2 of 5 code	May 24, 2015
V1.05	Disable USB as default mode, add Serial Port Protocol command specification	June 15, 2016
V1.06	Update model	June 21, 2016
V1.07	Enable USB transmission,update Serial Port Protocol command	June 25, 2016
V1.08	New flash mode	October 21, 2016
V1.1	Distinguish parameter and setup code	May 18, 2017

Content

Chapter 1 Getting Started.....	6
Brief Introduction.....	6
Feature	7
Application Field	7
Appearance	7
Data Interface.....	10
Chapter 2 Barcode Scanner Parameter.....	11
Physical Parameter.....	11
Performance Parameter.....	12
Depth of field.....	13
User Environment.....	13
Chapter 3 System Setting	14
Introduction.....	14
Check the version.....	14
Send Enter Setup Barcode	16
Scan mode.....	17
Buzzer Setting (default).....	21
Chapter 4 Data Edition.....	22
Introduction.....	22
USB Keyboard Types for Countries	22
RS232 Interface.....	25
Chapter 5 Symbologies.....	33
Introduction.....	33
EAN-8.....	33
EAN-13.....	34
Codabar.....	38

Code 11	39
Code 39	39
Code 93	41
Code 128	42
GS1 DataBar Limited (RSS Limited)	42
GS1 DataBar Omnidirectional (RSS Omnidirectional)	43
UPC-A	44
UPC-E.....	46
Interleaved 2 of 5	47
Industrial 2 of 5.....	48
Standard 2 of 5.....	48
Matrix 2 of 5	49
MSI	49
Plessey	50
Chapter 6 Appendix.....	52
Appendix A.....	52
Appendix B (ASCII)	53
Appendix C (Features Linked Table)	59

Chapter 1 Getting Started

Introduction

BC-076 Supporting by PC interface like USB, RS232, BC-076 scanner is a sort of 1D handheld barcode scanner, and also able to deliver rapid barcode acquisition and accurate decoding; it can provide customers with best services competitive price. BC-076 scanner suits to be used in supermarket, shopping mall and warehouse.

With patent design, BC-076 scanner boasts the ergonomic trigger and handle that ensures easy and comfortable operation. 32-bit processor provides 300 scans per second, Integrated core component guarantees the reliability and stability of the product, and decrease the rate of barcode scanner failure.

Feature

- Linear barcode scanning: fast and easy to scan print code, paper code, screen code, and have nice performance in scanning abrasion code, fuzzy code and even damaged code
- Humanization design: ergonomic design ensures easy and comfortable operation
- Plug and play: Universal data interfaces ,support multiple Linux, MAC, Windows systems perfectly
- Directly feedback by customer: high red light Aim Line, visual and suitable with natural light. High quality LED indicator and buzzer also promote a direct user's experience
- Mobile Payment: Support all kinds of 1D screen codes

Application Field

Medical, supermarket, retail trade, industry and mobile payment.

Appearance

BC-076 Left View

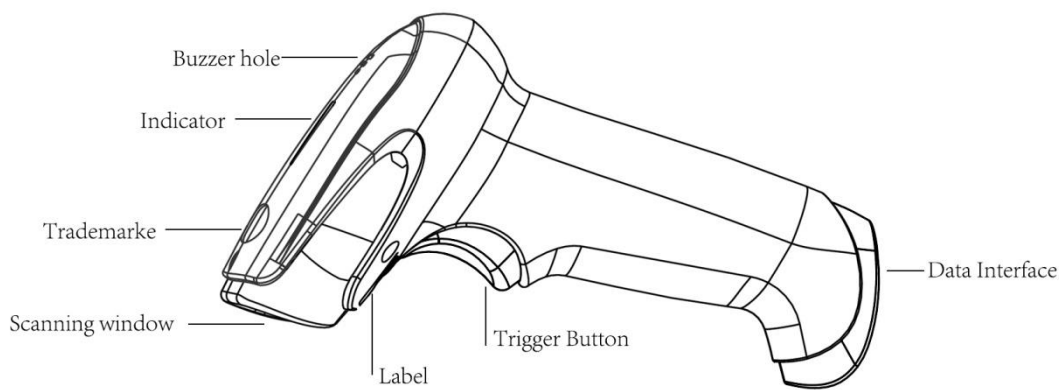

Dimensions (unit: mm)

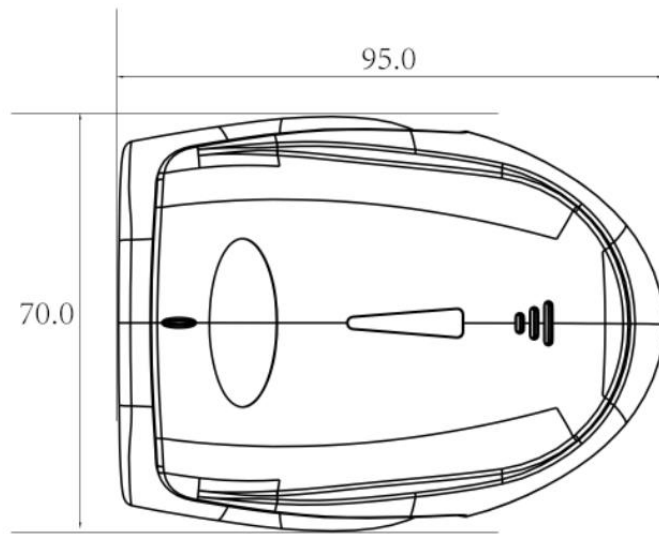
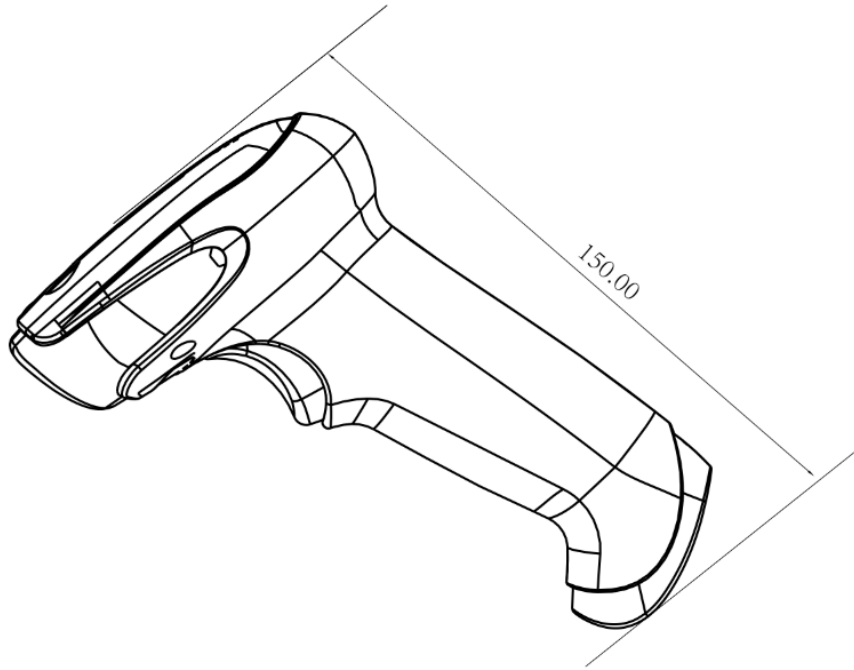

Data Interface

BC-076 applies RJ45 10P10C data interface, the following are the PIN name and signal of RJ45.

Pin No.	USB Function	RS232 Function
3	D+	TXD
5	D-	RXD
6	VCC	VCC
8	GND	GND

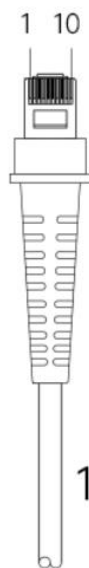

RJ45
10P10C

BC-076 scanner must be operated with a connected main engine which refers to PC host, POS and Android host etc.

USB interface

Pin No.	Function
1	Vcc
2	D-
3	D+
4	GND

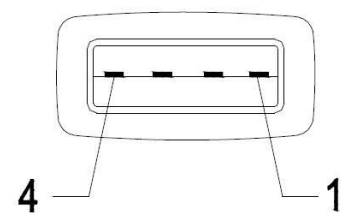

RS232 interface

Pin No.	Function
2	TXD
3	RXD
5	GND
9	Vcc/+5V
Power Lead	Vcc/+5V

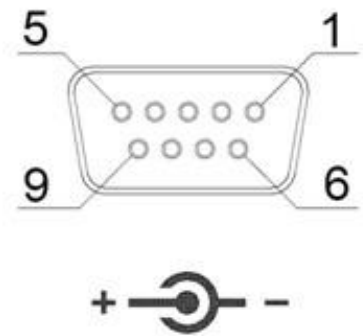

Chapter 2 Barcode Scanner Parameter

Physical Parameter

Physical Parameter	
Weight (USB)	<110g (not include cable)
Material	ABS
Device Dimension	95mm H * 70mm W * 150mm L
Package Dimension	215mm L * 100mm W * 75mm H
Cable Length	1.5m
Interface	USB (USB-KBW/USB-COM) 、 RS232

Performance Parameter

Performance Parameter	
Light source	632nm red light
Sensor	Linear CCD Sensor
Processor	ARM32-bit
Decoding speed	Up to 300 times/sec
Resolution	$\geq 4\text{mil}/0.1\text{mm}@PCS90\%$
Depth of field	10-600mm
Scan mode	Manuel, automatic, sensing, continuous
Promoting mode	Buzzer, LED indicator light
Scanning angle	Pitch: $\pm 50^\circ$ Roll: $\pm 30^\circ$ Skew: $\pm 50^\circ$
Power adapter	input: DC5V, 1A output: AC100~240V, 50~60Hz
Current	80mA (work) ; 30mA (standby)
Ambient illumination	100,000Lux Max
Decode Capability	EAN-8, EAN-13, Codabar, CODE11, CODE 39, CODE 93, CODE128, China Post, German Post, GS1-128, GS1 Limited, GS1 Omnidirectional, UPC-A, UPC-E, ISBN/ISSN, ISBT, Interleaved 2 of 5, ITF14, Matrix 2 of 5, Industrial 2 of 5, MSI, Plessey, etc.

Depth of field

Range of decoding			
Code 39	0.1mm(4mil)	70mm	100mm
Code 39	0.127mm(5.0mil)	60mm	150mm
Code 39	0.5mm(20mil)	30mm	450mm
Code 39	1.0mm(40mm)	150mm	600mm
UPC/EAN	0.33mm(13mil)	30mm	300mm

Test condition: 25°C indoor, ambient illumination 200LUX, PCS=0.9

User Environment

Environment Parameter	
Operating Temperature	-20°C to 50°C
Storage Temperature	-40°C to 70°C
Relative Humidity	5% to 95% (non-condensing)
IP Level	Ip42
Drop test	1.5meter, 100times
Temperature test	30 minutes for high Temp., 30 minutes for low Temp.,
Highest temp	60°C
Lowest temp	-20°C
Shock resistance	10H@125RPM

Chapter 3 System Setting

Introduction

The scanner can be configured by scanning programming barcodes. All user programmable features/options are described along with their programming barcodes/commands in the following sections.



Scanning introduction

Manual scanning mode, please follow the scanning steps:

1. Press and hold the trigger button, light is activated, and then appear the red light and the red light of sight.
2. Aim the center of the codes by red light of sight, moving the scanner between the codes to find the best scanning distance.
3. Decode successfully when you hear the sound from the buzzer and the red light off, the codes will be transmitted to the host.

Notice: During scanning the same series codes, you will find there will be a highly success rate between the scanner and the codes in some distance, this refers to the best reading distance.

Factory Defaults

Scanning the following barcode can restore the scanner to the factory defaults.

You may need to reset your scanner when:

1. scanner is not properly configured so that it fails to decode barcodes;
2. you forget previous configuration and want to avoid its impact;
3. functions that are rarely used have been enabled for the time being.

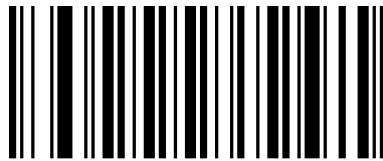

000B0

Restore All Factory Defaults

Check the version

Scanning the code to check the scanner version.



000A0

Check the version

Send Enter Setup Barcode

Enter Setup can be sent to the host. When you set < Enter Setup Barcode Permission >successfully, the content of Enter Setup Barcode will be sent to the host. When you set < Enter Setup Barcode Forbidden >successfully, the content of Enter Setup Barcode will not be sent to the host. The Default is < Enter Setup Barcode Forbidden >.

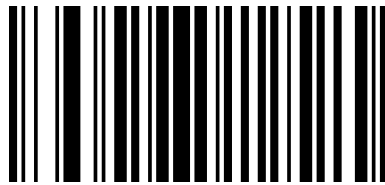

02501

Enter Setup Barcode Permission

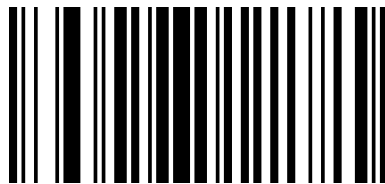

02500

Enter Setup Barcode Forbidden*

Scan mode

Manual mode

Manual Mode (default): Users can setup the scan mode according to their needs. A trigger pull activates a decode session. The decode session continues until the barcode is decoded or the trigger is released or the decode session timeout expires.

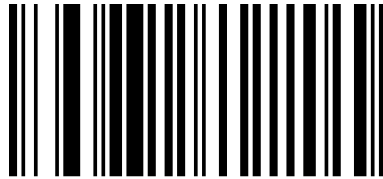

013300

Manual Mode*

Continuous Mode

Continuous Mode: Users can setup an Auto Continuous Mode. When you setup this mode successfully, the red light of the scanner will always on, and will read it automatically when the barcodes pass by. When you meet with the same barcode, you need to remove to reread this barcode.

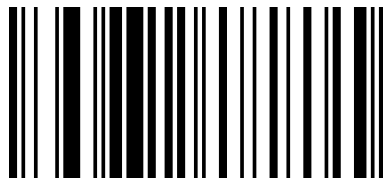

013304

Auto Continuous Mode

Users can also setup a Trigger Delay Mode, when you setup this mode successful, the red light of the scanner will on 3 seconds, and will off when you read the barcode after 3 second. The red light will turn off when you read the barcode successfully.

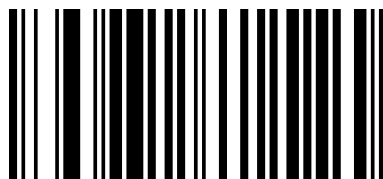

013301

Trigger Delay Mode

Trigger Timeout

When users use <Trigger Delay Mode>, you can setup the timeout according to your needs, the default timeout is 3 seconds, the timeout ranges from 1s to 9.9s.



023510

set timeout to 1S

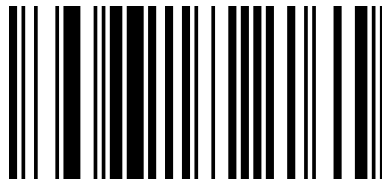

023530

set timeout to 3S*



023550

set timeout to 5S

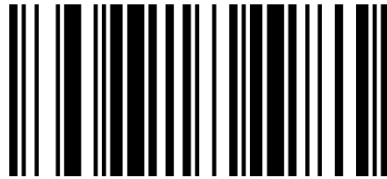

023599

set timeout to 9.9S

Data transmission speed

The scanner can control the transmission speed by scanning the programming codes. For some non-standard Windows USB interface (i.e. through PS2 to connect USB interface), this interface can be cut down the transmission speed to guarantee the integrity and stability of the barcode scanner. The default is to close the USB high speed transmission, by using the <full speed transmission mode>.

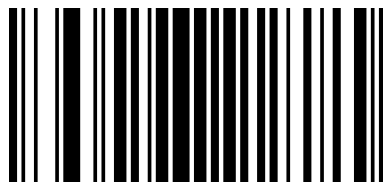

02301

USB High Speed

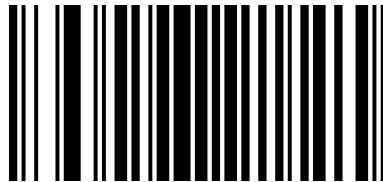

02302

USB Full Speed

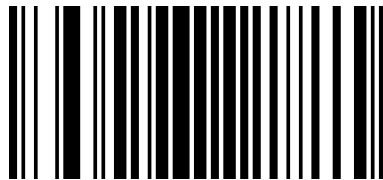

02300

To close USB High Speed Transmission*

Users can setup the speed of the USB device.

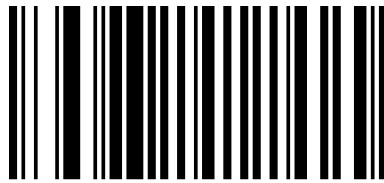

001500

High Transmission Speed

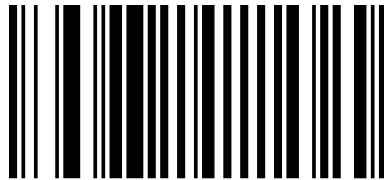

001502

Middle Transmission Speed

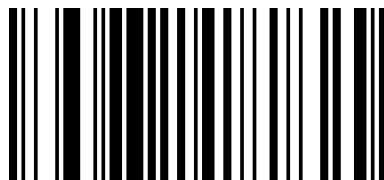

001504

Slow Transmission Speed

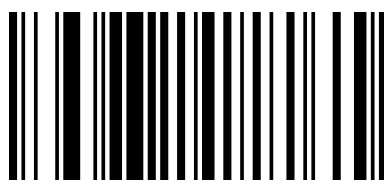

001506

Slowest Transmission Speed

Buzzer Setting (default)

When users read a barcode successfully, you will hear buzzer sound once, and also you can turn it on or off according to your needs.

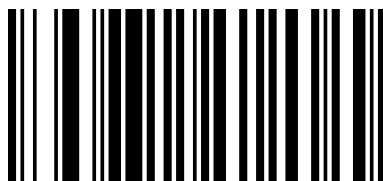

014201

Buzzer on*

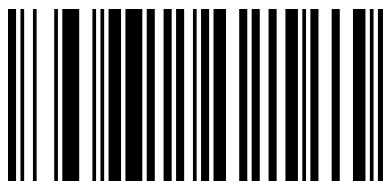

014200

Buzzer off

Chapter 4 Communication Settings

Introduction

The scanner provides a USB interface to communicate with the host device. The host device can receive scanned data and send commands to control the scanner or to access/alter the configuration information of the scanner via the USB interface.

USB Keyboard Types for Countries

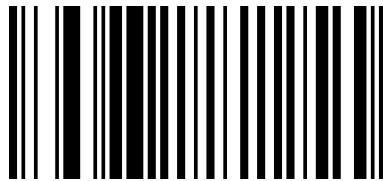

000602

USB Keyboard(default)*

Country/language Choose

Keyboard layouts vary from country to country. All supported keyboard types are listed below.



0005000

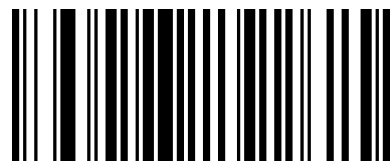

0005001

U.S./China (American English) *

Canada (French)

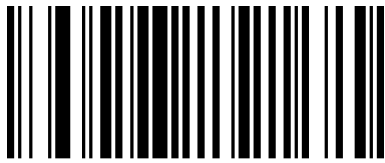

0005002

Netherland (Dutch)

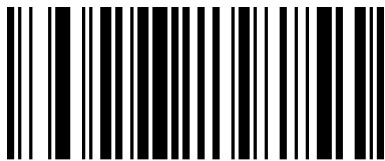

0005004

Argentina (Spanish)

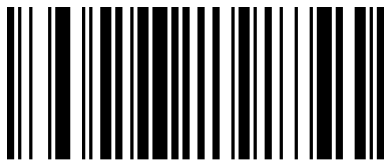

0005006

Denmark (Danish)



0005008

Italy (Italian)

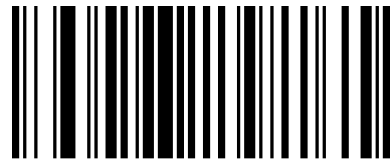

0005003

Spain (Spanish)

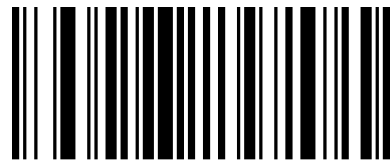

0005005

Brazil (Portuguese)

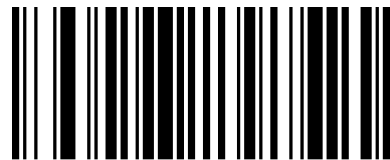

0005007

UK (British English)

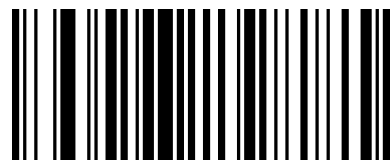

0005009

France (French)

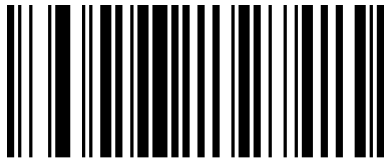

0005010

Germany (German)

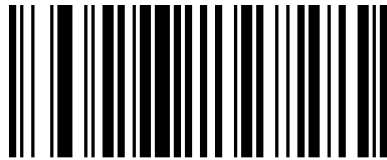

0005011

Norway (Norsk)

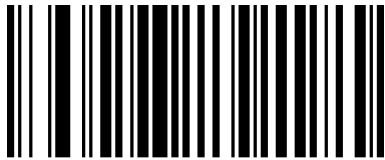

0005012

Sweden/Finland (Swedish/Finnish)

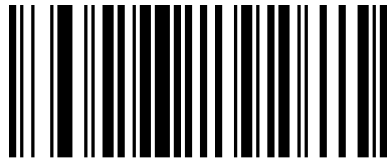

0005013

Slovakia (Slovak)



0005014

Portuguese (Portuguese)

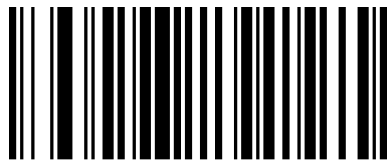

0005015

Czech (Czech)



0005016

Belgium (Dutch)

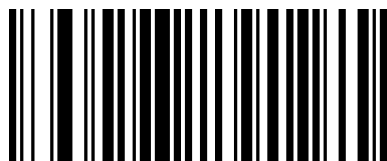

0005017

Turkish-F



0005018

Turkish-Q

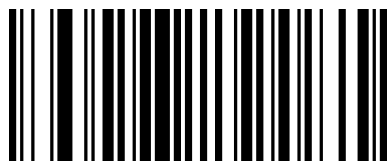

0005019

Poland (Polish 214)

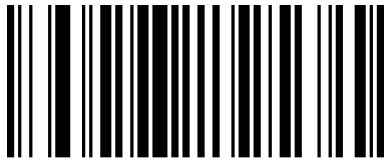

0005020

Switzerland (German/French)

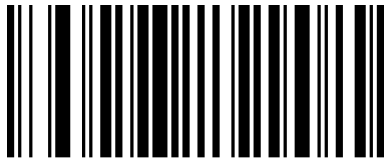

0005022

Hungary (Hungarian)

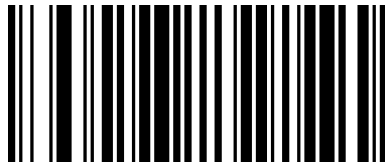

0005024

Russia (Russian)

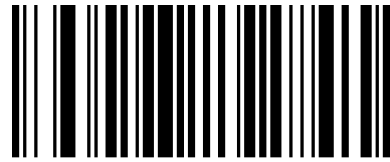

0005021

Croatia (Srb-Crt)

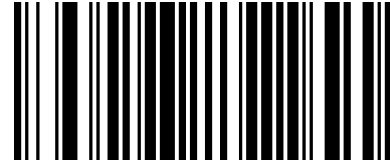

0005023

Japan (Japanese)

USB COM Port Emulation

This feature allows the host to receive data in the way as a serial port does. However, you need to set communication parameters on the scanner to match the Host requirements. A driver is required for this feature.

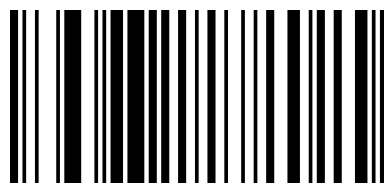

000603

USB COM Port Emulation

Note: In USB COM Port Emulation, the port protocol parameter of the scanner can match the port parameter of application of the host automatically.

RS232 Interface

Serial communication interface is usually used to connect the scanner to a host device (like PC, POS). When the scanner is connected to a host device through its RS-232 interface, you need to set communication parameters to match the host device.

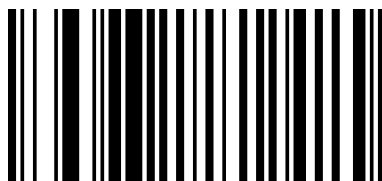

000601

RS232 Serial Port

Baud rate

Baud rate is the number of bits of data transmitted per second. Set the scanner's baud rate to match the host requirements. All supported baud rate are listed below.

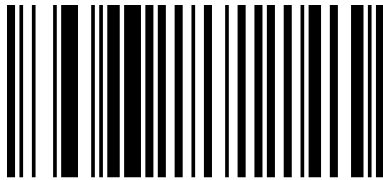

000701

600bps

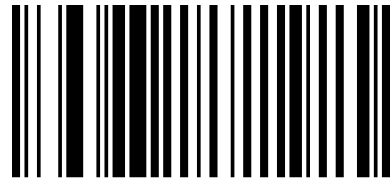

000702

1200bps

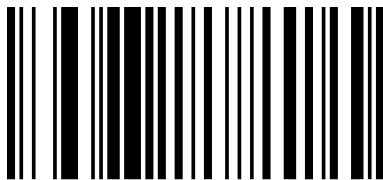

000703

2400bps

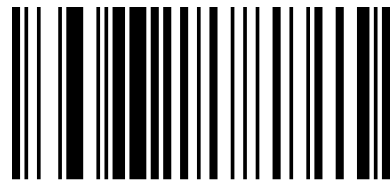

000704

4800bps

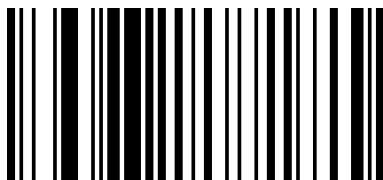

000705

9600bps*

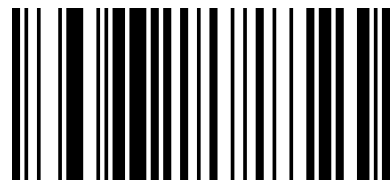

000706

19200bps

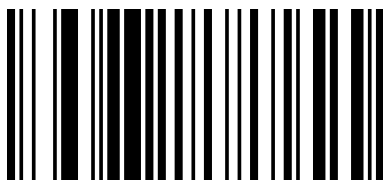

000707

38400bps

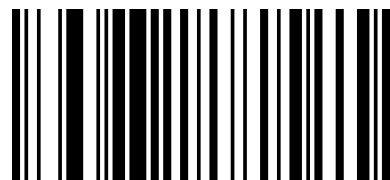

000708

57600bps

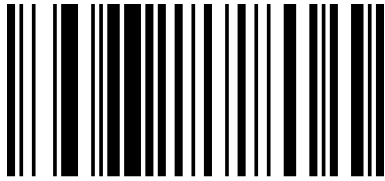

000709

115200bps

Chapter 5 Data Edition

Introduction

After a successful barcode read, a string containing numbers, letters or symbols will be returned. In real applications, barcode data may be found insufficient for your needs. You may wish to include additional information such as barcode type, data acquisition time or delimiter in data being scanned. Adding extra information to printed barcodes does not seem like a sensible solution since that will increase the barcode size and make them inflexible. Instead, we come up with the idea of appending prefix and suffix to the data without making any change to barcodes. We will show you how to conduct the configuration in the following sections.

Note: Customized data: <Prefix> <Data><Suffix><Terminating Character>

Terminating Character Setting

Corresponding terminating character can be added during using the scanner to meet the user's requirements

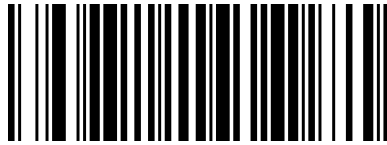

0212@r

Add Return CR*

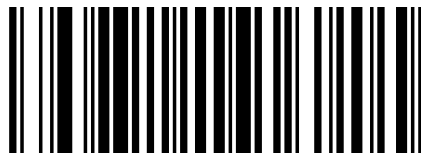

0212@n

Add Newline LF*

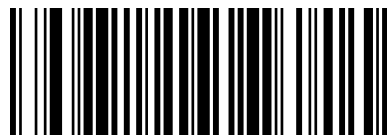

0213@r\n

Add Return and Newline

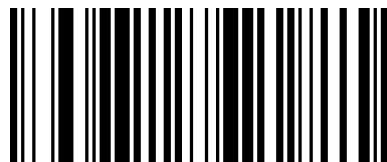

0210@

None

Code ID Setting

Users usually need to know barcode type in the process of scanning, you can use Code ID prefix to recognize the barcode type. Please read “Appendix A” for the reference of the Code ID corresponding barcode type. No Code ID default setting.

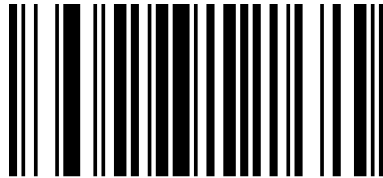

01400

Enable Code ID*

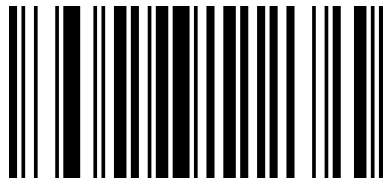

01401

Disable Code ID (prefix)

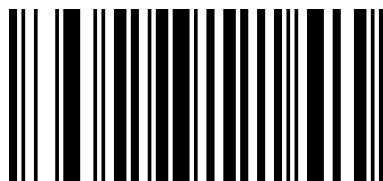

01402

Enable Code ID (suffix)

Convert Case

This parameter is valid when the Covert Case is set. When the Convert All to Lower Case feature is enabled, barcode data “aBC123” is transmitted as “abc123”.

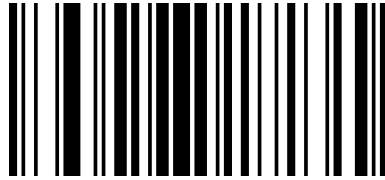

02510

No Case Conversion*

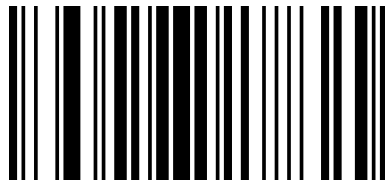

02511

Convert All to Upper Case

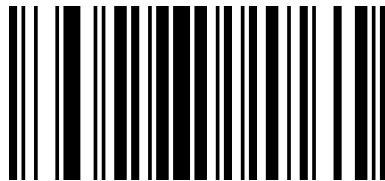

02512

Convert All to Lower Case

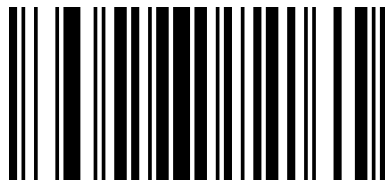

02513

Invert Upper and Lower Case Characters

Custom Prefix and Suffix

Users can custom the prefix and suffix of the output code for your requirements. For example, when you add prefix “VC” to barcode “123”, the host will receive “VC123”. When you add suffix “DE” to barcode “123”, the host will receive “123DE”.

Set Custom Prefix

To set a custom prefix, scan the “Add Prefix” barcode first, then scan the corresponding barcode in "Appendix B" for your requirement, at last setting is done.

Note: A custom prefix cannot exceed 32 characters.

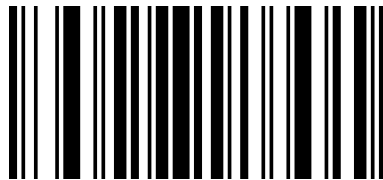

02240

Add Prefix

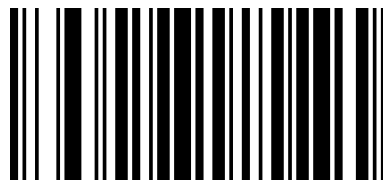

02220

Clear All Prefix

Set Custom Suffix

To set a custom suffix, scan the “Add Suffix” first, then scan the corresponding barcode in "Appendix B" for your requirement, at last setting is done.

Note: Terminating character is not including when eliminate the suffix characters.

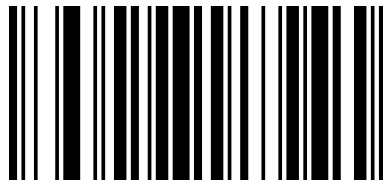

02241

Add Suffix

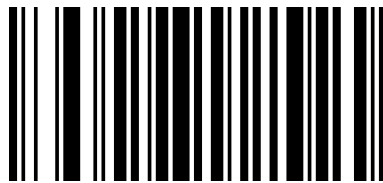

02200

Clear All Suffix

Note: When you clear suffix, you will not clear the terminating character.

Quit setting prefix and suffix

Scan the "Quit Adding the Prefix & Suffix" programming codes when you don't want to add the prefix & suffix after the "Add Prefix/Suffix" being scanned.

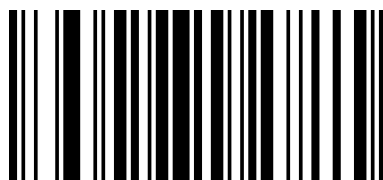

02242

Quit Adding the Prefix & Suffix

Chapter 6 Symbologies

Introduction

Every symbology (barcode type) has its own unique attributes. This chapter provides programming barcodes for configuring the scanner so that it can identify various barcode symbologies. It is recommended to disable those that are rarely used to increase the efficiency of the scanner.

EAN-8

Enable/Disable EAN-8

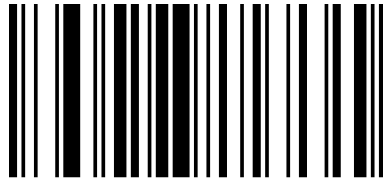

00371

Enable EAN-8*

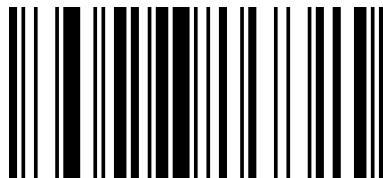

00370

Disable EAN-8

Transmit Check Digit

EAN-8 is 8 digits in length with the last one as its check digit used to verify the integrity of the data. The default mode opens “transmit EAN-8 Check Digit”. Users can scan the code below to choose it.

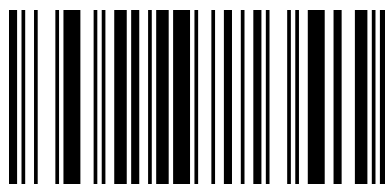

00571

Transmit EAN-8 Check Digit*

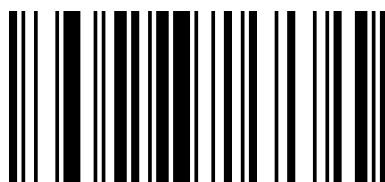

00570

Do Not Transmit EAN-8 Check Digit

Add-On Code

An EAN-8 barcode can be augmented with a two-digit or five-digit add-on code to form a new one. In the examples below, the part surrounded by blue dotted line is an EAN-8 barcode while the part circled by red dotted line is add-on code. The default mode opens “Disable Add-on Code”. Users can take “Add-On Code Setting” for reference.

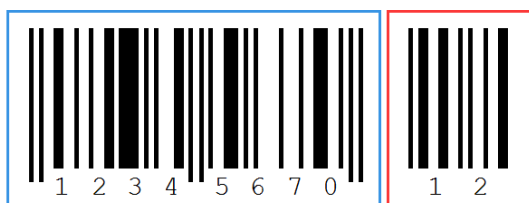

EAN-13

Enable/Disable EAN-13

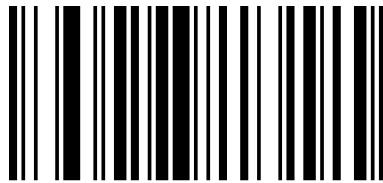

00361

Enable EAN-13*

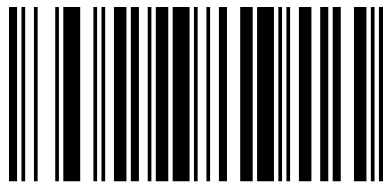

00360

Disable EAN-13

Transmit Check Digit

EAN-13 is 13 digits in length with the last one as its check digit used to verify the integrity of the data. The default mode opens “Transmit EAN-13 Check Digit”. Users can choose to send it or not.

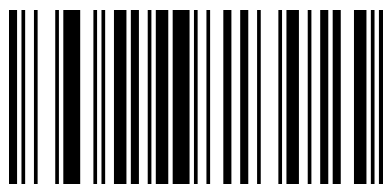

00461

Transmit EAN-13 Check Digit*

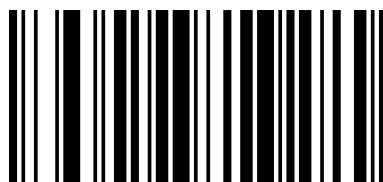

00460

Do Not Transmit EAN-13 Check Digit

Add-On Code

An EAN-13 barcode can be augmented with a two-digit or five-digit add-on code to form a new one. In the examples below, the part surrounded by blue dotted line is an EAN-13 barcode while the part circled by red dotted line is add-on code. Users can take “Add-On Code Setting” for reference.



EAN-13 Transfer to ISBN

The International Standard Book Number (ISBN) is a unique numeric commercial book identifier. The ISBN is 13 digits long, When you scan “EAN-13 Transfer to ISBN” programming code, the output code will be 10 digits long ISBN code. The default closes this mode.

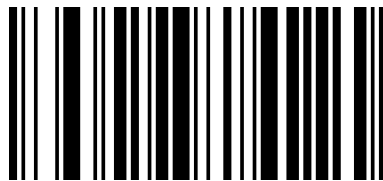

00481

Enable EAN-13 Transfer to ISBN

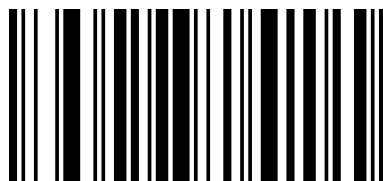

00480

Disable EAN-13 Transfer to ISBN

EAN-13 Transfer to ISSN

An International Standard Serial Number (ISSN) is used to uniquely identify a serial publication. When you scan “EAN-13 Transfer to ISSN” programming code, the output code will be 10 digits long ISSN code. The default closes this mode.

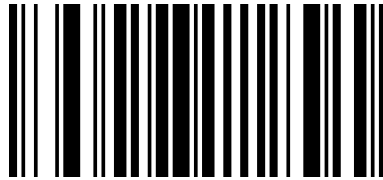

01501

Enable EAN-13 Transfer to ISSN

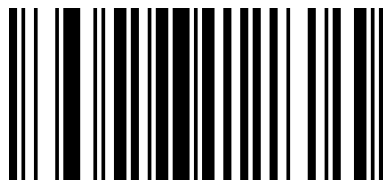

01500

Disable EAN-13 Transfer to ISSN

Codabar

Enable/Disable Codabar

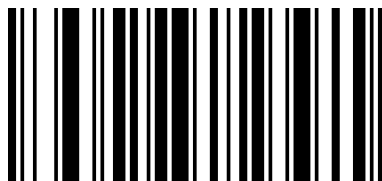

00851

Enable Codabar



00850

Disable Codabar

Start/Stop Characters



00861

Enable Codabar Start/Stop Characters



00860

Disable Codabar Start/Stop Characters*

Code 11

Enable/Disable Code 11

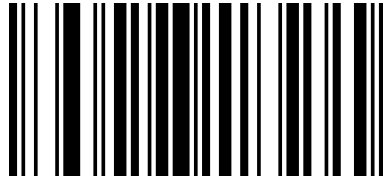

01261

Enable Code 11*

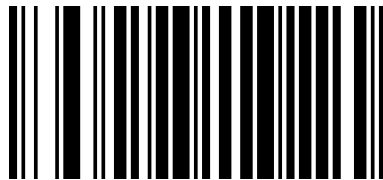

01260

Disable Code 11

Code 39

Enable/Disable Code 39

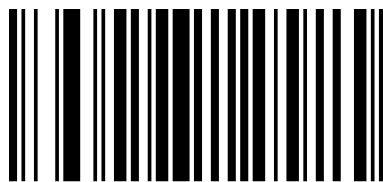

00221

Enable Code 39*

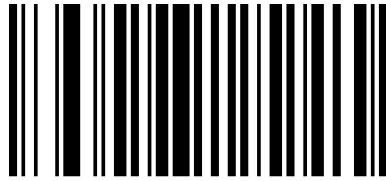

00220

Disable Code 39

Start/Stop Characters

There is a code like this <*Code39*>, These hash keys refers to Start and Stop, you can set it whether the start and stop character transmit with the barcode.

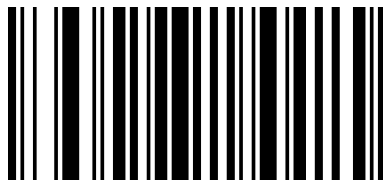

00281

Enable Code39 Start/Stop Characters

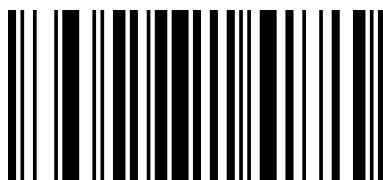

00280

Disable Code39 Start/Stop Characters*

Enable/Disable Code 39 Full ASCII

The scanner can be configured to identify all ASCII characters by scanning the appropriate barcode below.

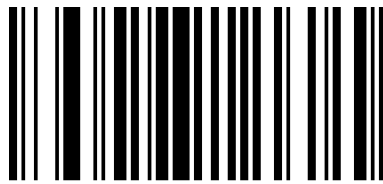

00231

Enable Code 39 Full ASCII*

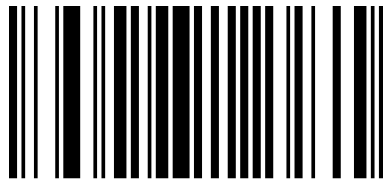

00230

Disable Code 39 Full ASCII

Code 93

Enable/Disable Code 93

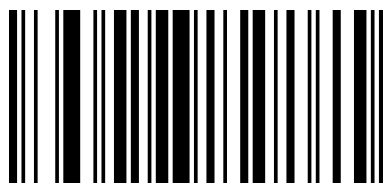

00621

Enable Code 93*

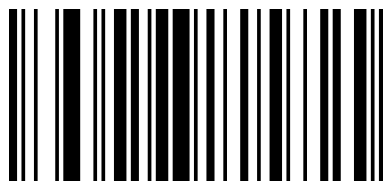

00620

Disable Code 93

Code 128

Enable/Disable Code 128



00691

Enable Code 128*

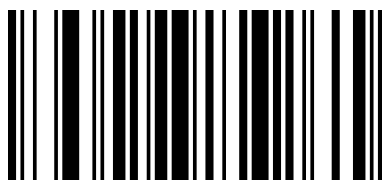

00690

Disable Code 128

GS1 DataBar Limited (RSS Limited)

Enable/Disable RSS Limited

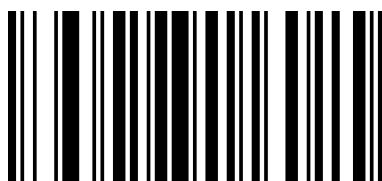

01771

Enable RSS Limited

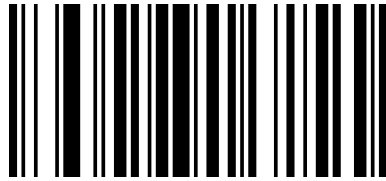

01770

Disable RSS Limited*

GS1 DataBar Omnidirectional (RSS Omnidirectional)

Enable/Disable RSS Omnidirectional

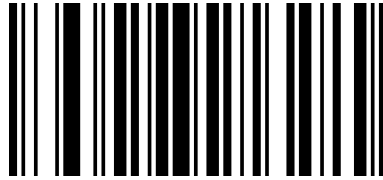

01671

Enable RSS Omnidirectional

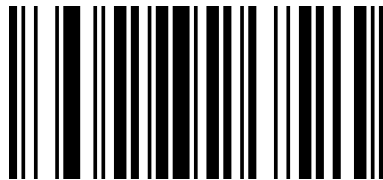

01670

Disable RSS Omnidirectional*

UPC-A

Enable/Disable UPC-A

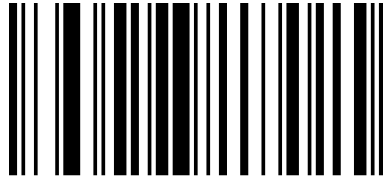

00341

Enable UPC-A*

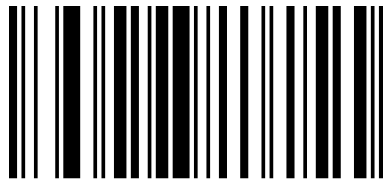

00340

Disable UPC-A*

Transmit Check Digit

UPC-A is 12 digits in length with the last one as its check digit used to verify the integrity of the data. The default mode opens “Transmit UPC-A Check Digit”. Users can choose to send it or not.

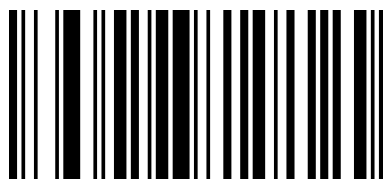

00421

Transmit UPC-A Check Digit*

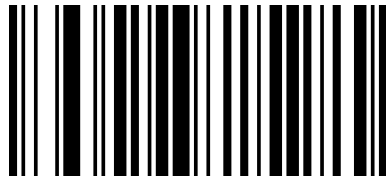

00420

Transmit UPC-A Check Digit

Add-On Code

A UPC-A barcode can be augmented with a two-digit or five-digit add-on code to form a new one. In the examples below, the part surrounded by blue dotted line is a UPC-A barcode while the part circled by red dotted line is add-on code. Users can take “Add-On Code Setting” for reference.

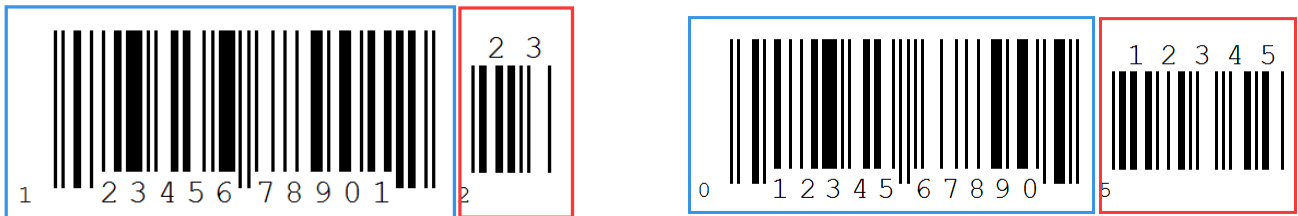

UPC-A transfer toEAN-13

Users can set to transfer UPC-A to EAN-13 according to your needs. The default closes this mode.

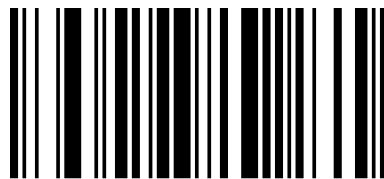

00391

Enable UPC-A Transfer to EAN13

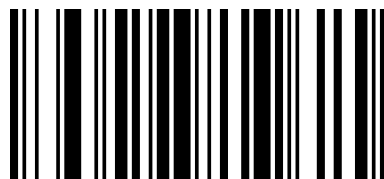

00390

Disable UPC-A Transfer to EAN13*

UPC-E

Enable/Disable UPC-E

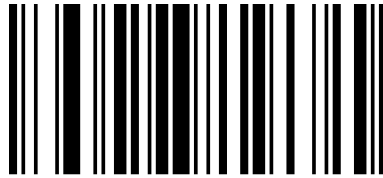

00351

Enable UPC-E*

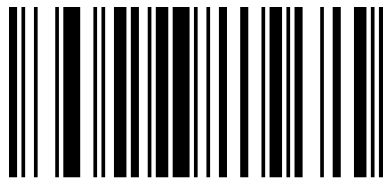

00340

Disable UPC-E

Transmit Check Digit

In the examples below, the part surrounded by blue dotted line is a UPC-A barcode while the part circled by red dotted line is add-on code. Users can take “Add-On Code Setting” for reference.



UPC-E transfer to UPC-A

Users can set to transfer UPC-E to UPC-A according to your needs. The default closes this mode.

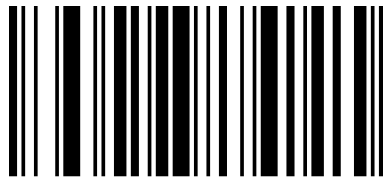

00381

Enable UPC-E Transfer to UPC-A

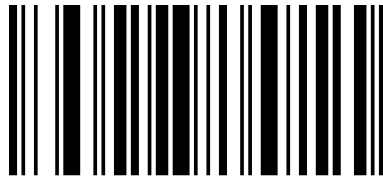

00380

Disable UPC-E Transfer to UPC-A*

Interleaved 2 of 5

Enable/Disable Interleaved 2 of 5

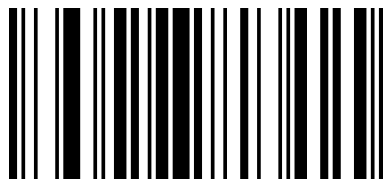

00961

Enable Interleaved 2 of 5*

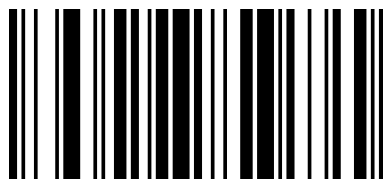

00960

Disable Interleaved 2 of 5

Industrial 2 of 5

Enable/Disable Industrial 2 of 5

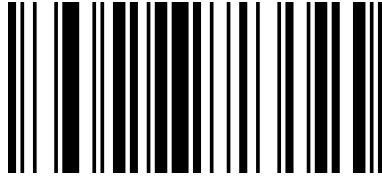

01061

Enable Industrial 2 of 5*

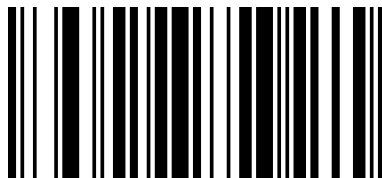

01060

Disable Industrial 2 of 5

Standard 2 of 5

Enable/Disable Standard 2 of 5

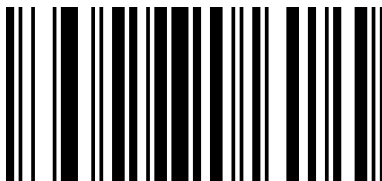

01871

Enable Standard 2 of 5*

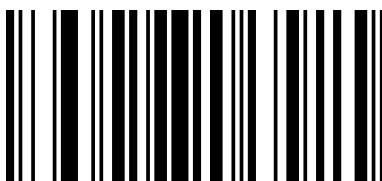

01870

Disable Standard 2 of 5

Matrix 2 of 5

Enable/Disable Matrix 2 of 5

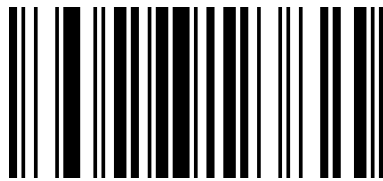

01461

Enable Matrix 2 of 5*

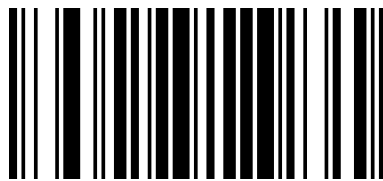

01460

Disable Matrix 2 of 5

MSI

Enable/Disable MSI

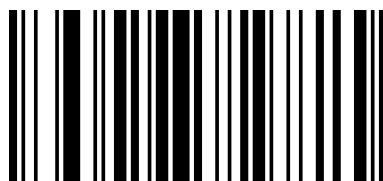

01151

Enable MSI

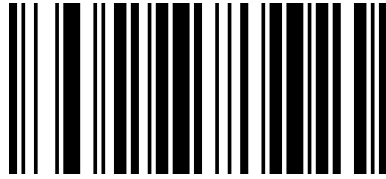

01150

Disable MSI*

Plessey

Enable/Disable Plessey

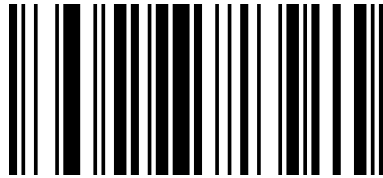

01161

Enable Plessey

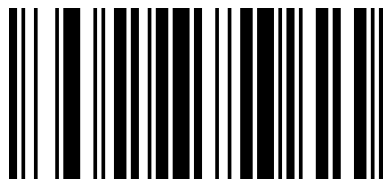

01160

Disable Plessey*

Add-On Code Setting

Users can scan the code below to open or close the setting of UPC/EAN/JAN.

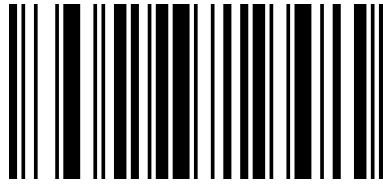

00551

Enable 2-Digit Add-On Code

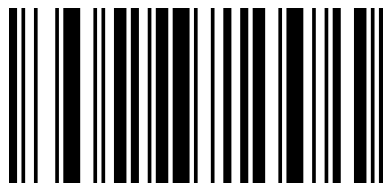

00552

Enable 5-Digit Add-On Code

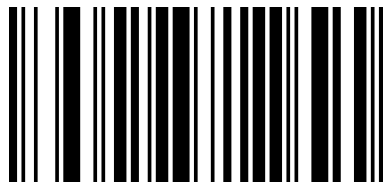

00553

Enable 2&5-Digit Add-On Code

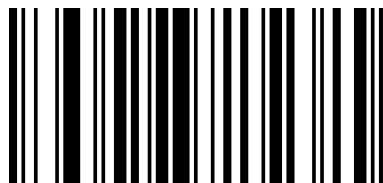

00550

Disable Digit Add-On Code*

Chapter 6 Appendix

Appendix A

Number	Code ID	Barcode Type (For prefix&Suffix)	Symbology
1	@	00	All Codes
2	A	01	CODE 128
3	C	03	EAN 8
4	D	04	EAN 13
5	E	05	UPC-A
6	F	06	UPC-E
7	I	09	CODE 93
8	J	0A	GS1 Omnidirectional
9	K	0B	GS1 Limited
10	M	0D	CODE 39
11	N	0E	Interleaved 2 of 5
12	O	0F	Industrial 2 of 5
13	P	10	Standard 2 of 5
14	Q	11	Matrix 2 of 5
15	S	13	MSI
16	T	14	Plessey
17	U	15	CODE 11
18	V	16	Codebar

Appendix B (ASCII)

1001

SOH (01)



1002

STX (02)

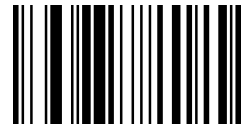

1003

ETX

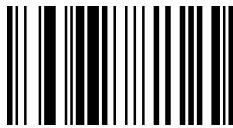

1004

EOT (04)



1005

ENQ (05)



1006

ACK (06)



1007

BEL (07)



1008

Backspace (08)



1009

HT (09)



1010

LF (0A)



1011

VT (0B)



1012

FF (0C)



1013

CR (0D)



1014

SO (0E)



1015

SI (0F)



1016

DEL (10)



1017

DC1 (11)



1018

DC2 (12)



1019

DC3 (13)

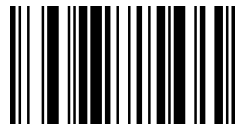

1020

DC4 (14)



1021

NAK (15)



1022

SYN (16)

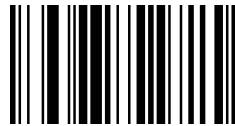

1023

ETB (17)

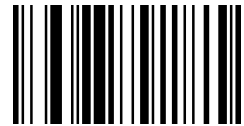

1024

CAN (18)



1025

EM (19)



1026

SUB (1A)



1027

ESC (1B)



1028

FS (1C)

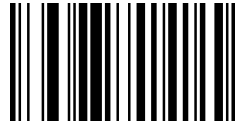

1029

GS (1D)



1030

RS (1E)



1031

US (1F)



1032

Space (20)



1033

! (21)



1034

“ (22)



1035

(23)



1036

\$ (24)



1037

% (25)

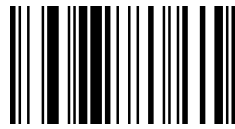

1038

& (26)



1039

' (27)



1040

((28)



1041

) (29)



1042

* (2A)



1043

+ (2B)

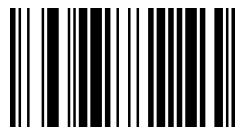

1044

, (2C)

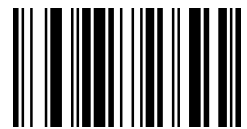

1045

- (2D)



1046

. (2E)

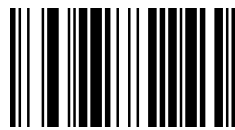

1047

/ (2F)

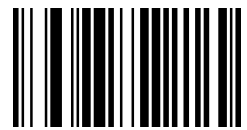

1048

0 (30)



1049

1 (31)

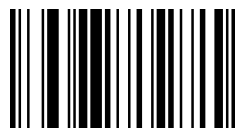

1050

2 (32)



1051

3 (33)



1052

4 (34)



1053

5 (35)



1054

6 (36)



1055

7 (37)

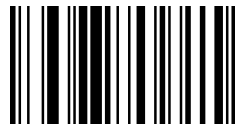

1056

8 (38)



1057

9 (39)



1058

: (3A)



1059

; (3B)



1060

< (3C)



1061

= (3D)



1062

> (3E)

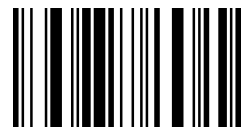

1063

? (3F)

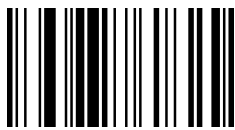

1064

@ (40)

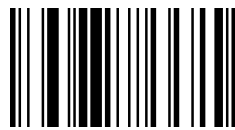

1065

A (41)

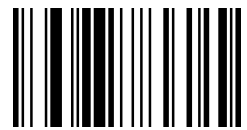

1066

B (42)



1067

C (43)

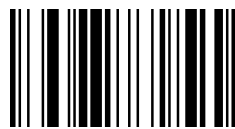

1068

D (44)



1069

E (45)

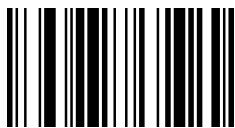

1070

F (46)

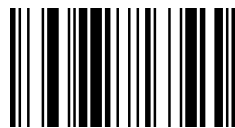

1071

G (47)

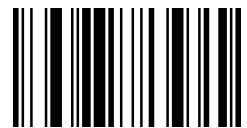

1072

H (48)

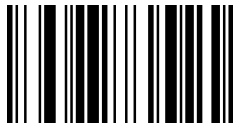

1073

I (49)

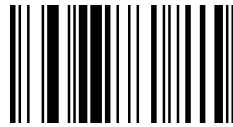

1074

J (4A)

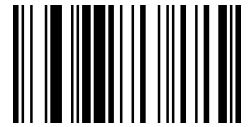

1075

K (4B)



1076

L (4C)

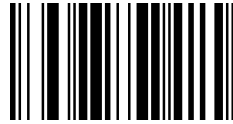

1077

M (4D)

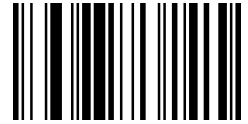

1078

N (4E)

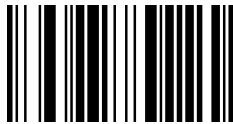

1079

O (4F)



1080

P (50)

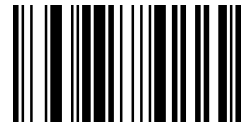

1081

Q (51)



1082

R (52)



1083

S (53)



1084

T (54)



1085

U (55)



1086

V (56)



1087

W (57)



1088

X (58)



1089



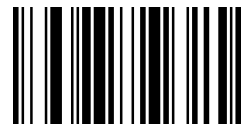

Y (59)



1090

Z (5A)

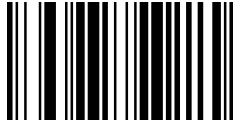
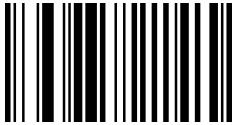
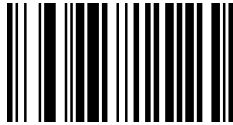
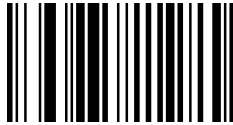
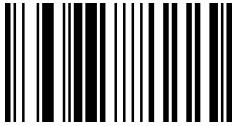
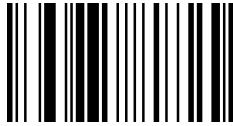
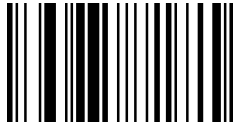
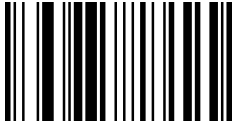
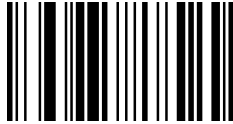
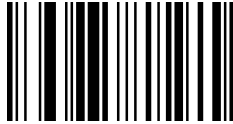
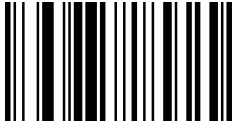
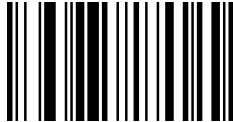
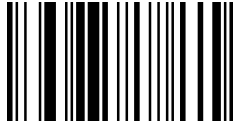

1091 [(5B) 	1092 \ (5C) 	1093] (5D) 
1094 ^ (5E) 	1095 _ (5F) 	1096 ` (60) 
1097 a (61) 	1098 b (62) 	1099 c (63) 
1100 d (64) 	1101 e (65) 	1102 f (66) 
1103 g (67) 	1104 h (68) 	1105 i (69) 
1106 j (6A) 	107 k (6B) 	1108 l (6C) 

1109 m (6D) 	1110 n (6E) 	1111 o (6F) 
1112 p (70) 	1113 q (71) 	1114 r (72) 
1115 s (73) 	1116 t (74) 	1117 u (75) 
1118 v (76) 	1119 w (77) 	1120 x (78) 
1121 y (79) 	1122 z (7A) 	1123 { (7B) 
1124 (7C) 	1125 } (7D) 	1126 ~ (7E) 

1127

Delete (7F)

Appendix C (Features Linked Table)



1128

F1 (80)



1129

F2 (81)



1130

F3 (82)



1131

F4 (83)



1132

F5 (84)



1133

F6 (85)



1134



1135



1136

F7 (86)



1137

F8 (87)



1138

F9 (88)



1139

F10 (89)



1140

F11 (8A)



1141

F12 (8B)



1142

Insert (8C)



1143

Home (8D)



1144

Page UP (8E)



1145

Delete (8F)



1146

End (90)



1147

Page Down (91)



1148

Right arrow (92)



1149

Left arrow (93)

Down arrow (94)

Up arrow (95)