

Table of Contents

Chapter 1 Introduction	2
1.1 Features.....	2
1.2 Outline.....	3
Chapter 2 General Specification	4
2.1 Tube Display.....	4
2.2 Electricity.....	5
2.3 Overall Dimensions.....	5
2.4 Environment.....	5
2.5 Driver Interface.....	5
2.6 User Settings.....	6
2.6.1FuctionSetting.....	6
Chapter 3 Interface	8
3.1 Interface.....	8
3.2 Interface Conversion Adapter.....	9
Chapter 4 Command Description	10
4.1 Command Set.....	11
4.1.1 LD220 Command Mode.....	11
4.1.2 EPSON Command Mode.....	12
4.1.3 UTC Standard Command Mode.....	15
4.1.4 UTC Enhance Command Mode.....	16
4.1.5 AEDEX Command Mode.....	16
4.1.6 ADM788 Command Mode.....	17
4.1.7 DSP800 Command Mode.....	18
4.1.8 CD5220 Command Mode.....	19
4.1.9 EMAX Command Mode.....	21
4.1.10 LOGIC Command Mode.....	22
Chapter 5 Character Set	23
5.1 U.S.A. / Standard Character Set (20h - 7Eh).....	23
5.2 International Character Selection.....	23
5.3 Character Code Table.....	24
5.3.1 Page 0 (PC437: U.S.A., Standard Europe).....	24
5.3.2 Page 1 (PC863: Canadian-French).....	26
5.3.3 Page 2 (Japanese Katakana).....	27
Chapter 6 Appearance	28

Chapter 1 Introduction

1.1 Features

The customer display is Vacuum Fluorescent Displays which display 20 columns and 2 lines, each columns is 5x7 dots.

Blue-green fluorescent color is easy on the eyes.

The display panel is movable so that it can be adjusted for the best viewing angle.

The customer display have different height by adjusting the support.

The interface of customer display is RS-232, with baud rates select from 9600 or 19200 bps.

The customer display have provided the pass through function to reduce the cable connection.

The user defined and international character sets are the standard of customer display.

Supports 10 command modes, with EPSON command mode set as default

Supports power from 5V to 12V, it prevents any mindless use of improper power input to cause malfunction

Easy configure & various settings through its free powerful set up software i.e. Welcome message and plenty of code pages setting and others setting.

Control boards design in top panel to prevent water or wet counter surface may damage from the bottom.

2nd Choice round-shape mini base for space-saving, stable and ingenious

Panel is structured to easy-detachable and available for wall mounting install and OEM

Attention

1. This specification shall apply only to the product(s) coming along with this manual inside.
2. This manual may not apply to the previous or later product(s).
3. This specification may be modified without any notice. If it is necessary for "customers" to have a latest manual about specification, please inquire your suppliers.

1.2 Outline

The customer display outline has included of three parts: the panel, the support, and the interface adapter



The standard VFD customer display should include following accessories:

Item	Description	Dimension (mm)	Q'ty
1	Panel of customer display	220(L)*87(W)*50(H)	1
2	Support	130	2
3	D-SUB 9PIN RS-232 Cable	1600	1
4	+5V PC 4P Plug Power Kit <i>or</i> PS/2 Power Kit <i>or</i> USB Power Kit <i>or</i> 100V~240V Universal Adapter (5V/2A) <i>or</i> 110V US <i>or</i> 230V Europe 2P Adapter (5V/2A)	100(W) x 59(D) x 33(H) 76(W) x 51(D) x 31(H)	1

※ **Above accessories may be different due to customers' requirement when delivery.**

Chapter 2 General Specification

2.1 Tube Display

Customer Display	Vacuum Fluorescent Display Blue Green
Display Pattern	5 x 7 Dot Matrix
Brightness	350~700 cd/m ²
Character Type	95 Alphanumeric & 32 International Characters
Character Size	5.25 mm (W) x 9.03 mm (H)
Character Number	40 (20 columns x 2 lines)
Character Pitch	Refer the figure 2.1

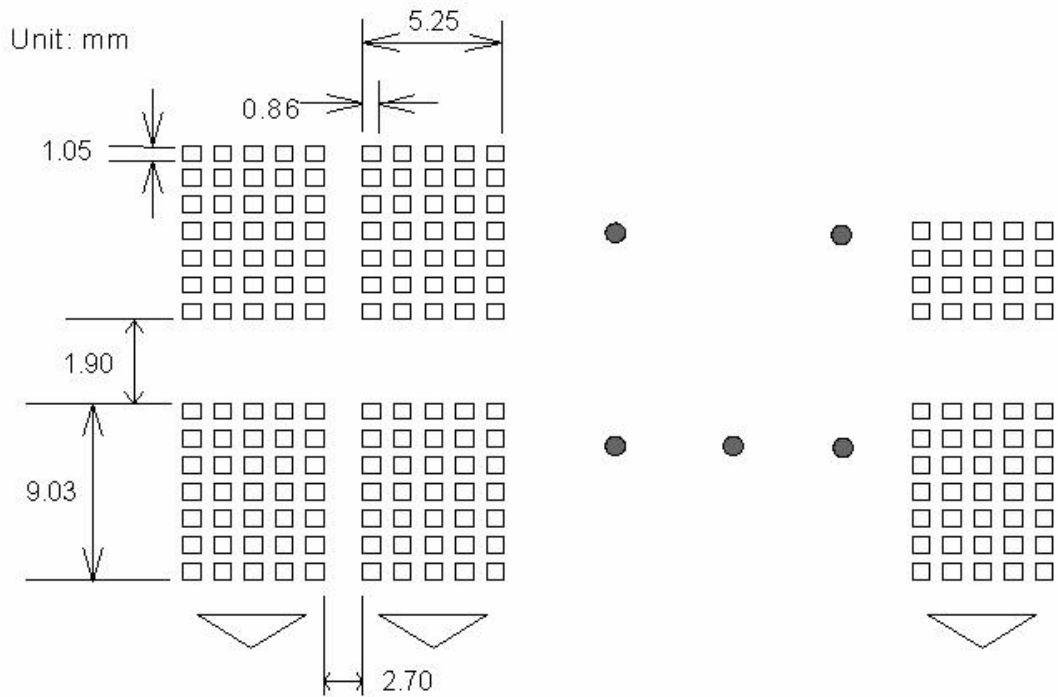

2.2 Electricity

Central Control Unit	CPU : STC ROM : 64K ROM RAM : 32K SRAM
Speed	CPU : 22 MHz
Connector	4 PIN (Female) USB Connector 9 PIN D-SUB Connector
Power Source	ONLY USB DC + 5V
Power Consumption	3 Watts Average (Maximum 15 Watts)

2.3 Overall Dimensions

Dimension of Panel :	220(L)* 87(W)* 50(H) mm
Dimension of Support One Support Two Support	One Support: 217* 106* 248 mm Two Support: 217* 106* 378 mm
Dimension of Base	217(L)* 106(W)* 33(H) mm
Viewing Angle	0°~60°
Horizontal Rotation	180°
Weight	980g

2.4 Environment

Operating Temperature	+10°C to +40°C
Storage Temperature	-10°C to +50°C
Relative Humidity	0% to 90% RH

2.5 Driver Interface

Interface	RS232
-----------	-------

2.6 User Setting

The default protocol is 9600 bps, non-parity, 8 data bits, 1 stop bit and with DTR/DSR control.



2.6.1 Function Setting

No switch, all user setting is set up by the default command set
or manufacturer

(I) Baud Rate Select

Function Description	Baud Rate (bps)
	9600(default)
	19200

(II) Command Type Select(Automatic identification)

Function Description	Software Defined
Command Type	Hex Code
LD220	00
EPSON POS D101	01
UTC Standard	02
UTC Enhance	03
AEDEX	04
ADM788	05
DSP800	06
CD5220	07
EMAX	08
LOGIC CONTEOL	09

(III) International Character Set

Function Description	
International Character Set (Code 20H-7FH)	Code Table (Code 80H-FFH)
U.S.A.	PC-437 (USA) (Standard European)
FRANCE	PC-850 (Multilingual)
GERMANY	PC-850 (Multilingual)
U.K.	PC-850 (Multilingual)
DENMARK I	PC-850 (Multilingual)
SWEDEN	PC-850 (Multilingual)
ITALY	PC-850 (Multilingual)
SPAIN	PC-850 (Multilingual)
JAPAN	Katakana
NORWAY	PC-865 (Nordic)
DENMARK II	PC-850 (Multilingual)
SLAVONIC/RUSSIAN	PC-437 (USA) (Standard European)
RUSSIAN	
GREEK	
CZECH	
LATIVAIN	

Chapter 3 Interface

3.1 Interface

Specifications:

Data Transmission Method : Asynchronous Serial.

Handshaking : DTR/DSR Control

Default Protocol : 9600/19200 bps, non-parity, 8 data bits, 1 stop bit.

Communication Protocol

1. Receive Data.

The DTR signal is as follows:

[HIGH] This indicates that the display isn't ready to receive data.

It depend on the following conditions:

The period from when the power is turned on to when the printer first becomes ready to receive data.

When the remaining space in the receiving buffer becomes 128 bytes or less.

When the DTR signal of the printer is HIGH when the printer is selected using the command.

[LOW] This indicates that the display is ready to receive data.

It depends on the following conditions:

When the printer first becomes ready to receive data after power-on.

When the remaining space in the receiving buffer becomes 128 bytes or more.

When the DTR signal of the printer is LOW when the printer is selected using the command.

2. Transmit Data.

After confirming the DSR is LOW, data is transmitted to printer.

3.2 Interface Conversion Adapter

The interface adapter section has connectors for the display panel, the printer, the power supply, and host computer. All the data transmitted from the host computer will be received by the display. If this data is for the display, the data will be processed, and if it is for the printer, it will be transmitted to the printer. Whether the data is for the display or the printer can be switched using the peripheral device selection command.

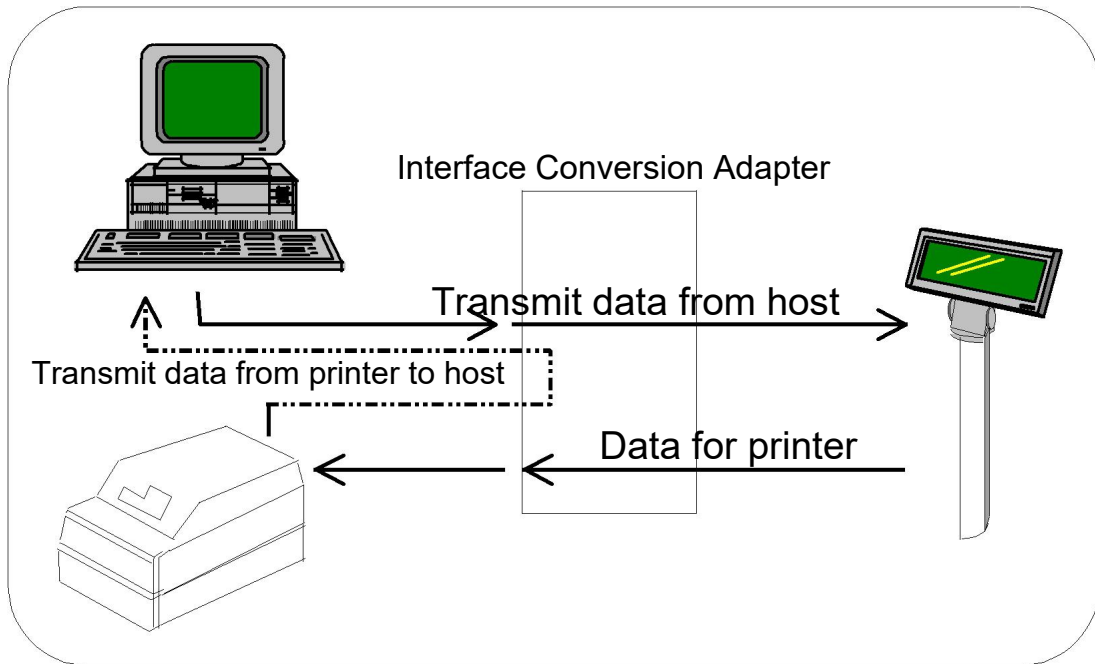

(II) Connector for Host Computer

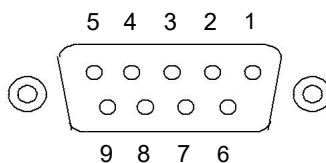

PIN Assignment

Pin No.	Signal	I/O	Description
1	NC		No Connection
2	TXD-	OUTPUT	Transmit Data
3	RXD	INPUT	Receive Data
4	DSR	INPUT	Data Set Ready
5	GND		Power GND
6	DTR	OUTPUT	Data Terminal Ready
7	CTS		Clear To Send
8	RTS		Request to Send
9	By Selection		N.C. or +5V ~ +12V

(III) Passthru Mode

PASS 1

For the printer with ESC/POS command

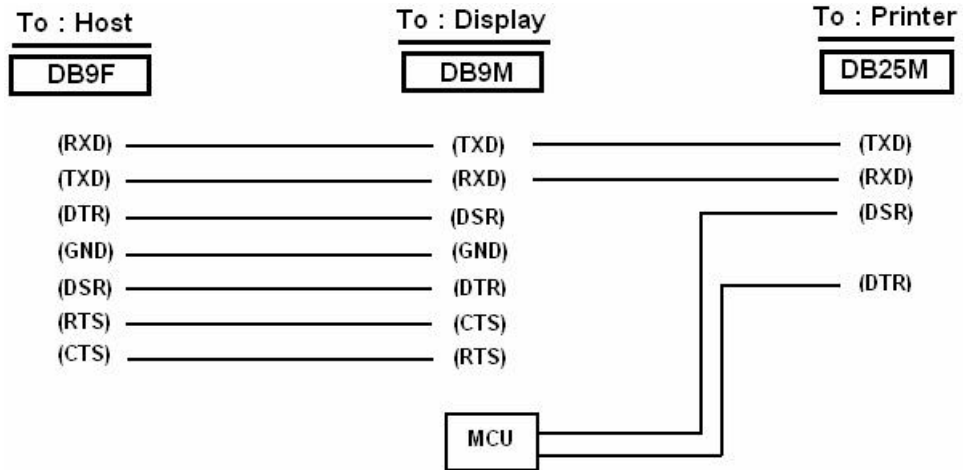

PASS 2

For the printer without ESC/POS command

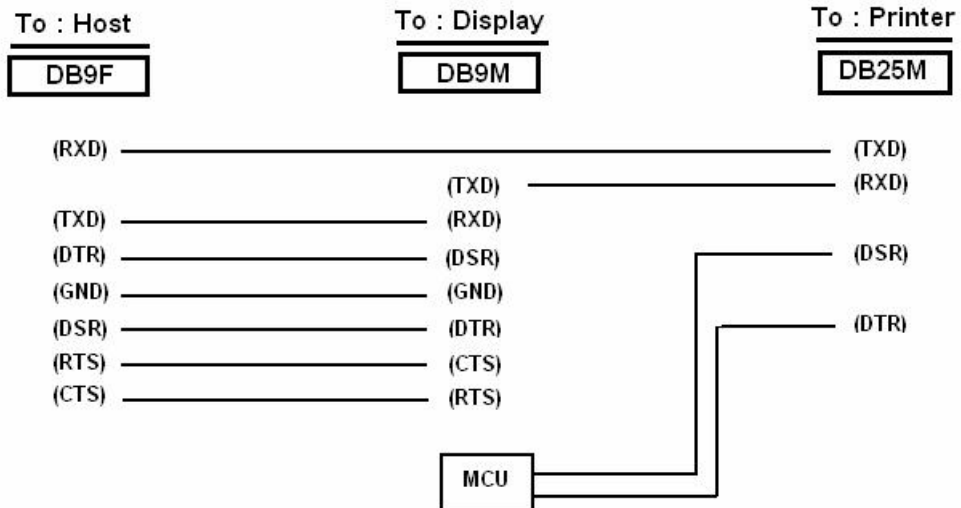

Chapter 4 Command Description

4.1 Command Set(Automatic identification)

4.1.1 LD220 Command Mode

Command	Hex	Function Description
HT	09	Move cursor right (Only valid in overwrite mode)
BS	08	Move cursor left (Only valid in overwrite mode)
CR	0D	Move cursor to left-most position (Only valid in overwrite mode)
ESC @	1B 40	Initialize customer display to initial state, clears display buffer, set display mode to shift and sets current display row to upper row
ESC U	1B 55	Select upper row as current row (Initial default)
ESC D	1B 44	Select lower row as current row
ESC A n	1B 41 n	Sets customer display disable or enable n=D, Disable ; n=E, Enable
ESC C r c	1B 43 r c	Move cursor to specified position (Only valid in overwrite mode) r=U, upper row ; r=D, lower row 1 ≤ c ≤ 20 (column number)
ESC E r n	1B 45 r n	Set special effect or display mode of specified row
ESC R n	1B 52 n	Set international font sets (Please refer International Font Set Table)
ESC = n	1B 3D n	Select peripheral n=1, printer ; n=2, display ; n=3, printer & display
ESC % n	1B 25 n	Set font pattern n=0, selected ; n=1, canceled
ESC & n s [p]	1B 26 n s data	Define user font pattern n=code for first character s=code for last character data=5 bytes required for each character

(REMARK)*Using commands “ESC E r n”, the value (Hex) of parameter
 r 58h=all rows
 55h=upper row
 44h=lower row
 n special function, the value is one of
 30h=shift mode (Default display mode)
 31h=rotation mode
 32h=blink mode
 33h=clear this row and switch to shift mode
 34h=overwrite mode
 35h=vertical mode

* International Font Set Table

n (Hex)	International Font Set	n (Hex)	International Font Set
30h	U.S.A	32h	FRANCE
31h	GERMANY	33h	JAPAN

4.1.2 EPSON Command Mode

Command	Hex	Function Description
HT	09	Move cursor right
BS	08	Move cursor left
US LF	1F 0A	Move cursor up
LF	0A	Move cursor down
US CR	1F 0D	Move cursor to right-most position
CR	0D	Move cursor to left-most position
HOM	0B	Move cursor to home position
US B	1F 42	Move cursor to bottom position
US \$ x y	1F 24 x y	Move cursor to specified position 1 ≤ x(column) ≤ 20 ; 1 ≤ y(row) ≤ 2
US C n	1F 43 n	Select/cancel cursor display n=0, canceled ; n=1, selected
CLR	0C	Clear display screen
CAN	18	Clear cursor line
US X n	1F 58 n	Brightness adjustment 1 ≤ n ≤ 4
US E n	1F 45 n	Blink display screen 0 ≤ n ≤ 255 (n*50msec) ON / (n*50msec) OFF n= 0, blinking is canceled n=255, display is turned off
ESC @	1B 40	Initialize display
ESC t n	1B 74 n	Select character code table 0 ≤ n ≤ 5 (Please refer " Chapter 5 ")
ESC R n	1B 52 n	Select international character set (Please refer International Font Set Table)
US r n	1F 72 n	Select/cancel reverse character n=0, canceled ; n=1, selected
US MD1	1F 01	Specify overwrite mode
US MD2	1F 02	Specify vertical scroll mode
US MD3	1F 03	Specify horizontal scroll mode
US . n	1F 2E n	Specify period display n= display character code
US , n	1F 2C n	Specify comma display n= display character code
US ; n	1F 3B n	Specify semicolon (period+comma) display n= display character code
US # n m	1F 23 n m	Specify display annunciator,, turn the annunciator at "m" column on or off n=0,1 (Off, On) ; 0 ≤ m ≤ 20
ESC & s n m [a(pl..p5)] (m-n+1)	1B 26 s n m [a(pl..p5)](m-n+1)	Define download characters s=1 ; 32 ≤ n ≤ m ≤ 126 ; a=5 (p1..p5 = pattern1..pattern5)
ESC ? n	1B 3F n	Cancel user-defined characters 32 ≤ n ≤ 126 (n=character code)

ESC % n	1B 25 n	Select/cancel download character set n=0, canceled ; n=1, selected
ESC W n s (x1 y1 x2 y2)	1B 57 n s (x1 y1 x2 y2)	Specify/cancel the window range n=1,2,3,4 (four windows) ; s=0,1 (disable, enable) 1 ≤ x1 ≤ x2 ≤ 20 (column) ; 1 ≤ y1 ≤ y2 ≤ 2 (row)
ESC = n	1B 3D n	Select peripheral device n=1, printer ; n=2, display ; n=3, printer & display
US :	1F 3A	Set starting/ending position of macro definition
US ^ n m	1F 5E n m	Execute and quit macro 0 ≤ (n,m) ≤ 255 n: specifies the time interval for display of characters in units of [n* 50msec] m: specifies the interval of macro execution every [m*50msec]
US @	1F 40	Execute self-test
US T h m	1F 54 h m	Display time :0 ≤ h ≤ 23 ; 0 ≤ m ≤ 59
US U	1F 55	Display of time counter

* International Font Set Table

n (Hex)	International Font Set	n (Hex)	International Font Set
00h	U.S.A.	06h	ITALY
01h	FRANCE	07h	SPAIN
02h	GERMANY	08h	JAPAN
03h	U.K.	09h	NORWAY
04h	DENMARK I	0Ah	DENMARK II
05h	SWEDEN		SLAVONIC/RUSSIA

※ Specify decimal point, comma, semicolon, annunciator*

(1) US . n (Decimal Point) / US , n (Comma) / US ; n (Semicolon):

The displayed character codes are from 32(20h) to 127(7Eh), and 128(80h) to 255(FFh) in the character code table. The period/comma/semicolon displayed only for n. The period is not displayed for the subsequent display characters.

(2) US # n m (annunciator):

[range] n = 0(00h) or 1(01h) / m = 0(00h)~20(14h)

[notes] When n= 0, the annunciator at column m is turned off.

When n= 1, the annunciator at column m is turned on.

"m" specify column number (the most left column is column 1) at which annunciator to be turned on/off is placed.

When m = 0, all annunciators are turned on or off.

Once an annunciator(s) is turned on, it remains on until turned off by this command, the ESC@ or US@ command is executed, or the power is turned off.

[example]: To turn on the annunciator at the third column:

[n = 01h], [m = 03h]

To turn off all the annunciators:

[n = 00h], [m = 00h]

※ Above commands relating decimal point, comma, semicolon, and annunciator may not be available due to hardware limit of display tube.

ESC % n	1B 25 n	Select/cancel download character set n=0, canceled ; n=1, selected
ESC W n s (x1 y1 x2 y2)	1B 57 n s (x1 y1 x2 y2)	Specify/cancel the window range n=1,2,3,4 (four windows) ; s=0,1 (disable, enable) 1 ≤ x1 ≤ x2 ≤ 20 (column) ; 1 ≤ y1 ≤ y2 ≤ 2 (row)
ESC = n	1B 3D n	Select peripheral device n=1, printer ; n=2, display ; n=3, printer & display
US :	1F 3A	Set starting/ending position of macro definition
US ^ n m	1F 5E n m	Execute and quit macro 0 ≤ (n,m) ≤ 255 n: specifies the time interval for display of characters in units of [n* 50msec] m: specifies the interval of macro execution every [m*50msec]
US @	1F 40	Execute self-test
US T h m	1F 54 h m	Display time 0 ≤ h ≤ 23 ; 0 ≤ m ≤ 59
US U	1F 55	Display of time counter

*** International Font Set Table**

n (Hex)	International Font Set	n (Hex)	International Font Set
00h	U.S.A.	06h	ITALY
01h	FRANCE	07h	SPAIN
02h	GERMANY	08h	JAPAN
03h	U.K.	09h	NORWAY
04h	DENMARK I	0Ah	DENMARK II
05h	SWEDEN		SLAVONIC/RUSSIA

※ Specify decimal point, comma, semicolon, annunciator*

(3) US . n (Decimal Point) / US , n (Comma) / US ; n (Semicolon):

The displayed character codes are form 32(20h) to 127(7Eh), and 128(80h) to 255(FFh) in the character code table. The period/comma/semicolon displayed only for n. The period is not displayed for the subsequent display characters.

(4) US # n m (annunciator):

[range] n = 0(00h) or 1(01h) / m = 0(00h)~20(14h)

[notes] When n = 0, the annunciator at column m is turned off.

When n = 1, the annunciator at column m is turned on.

"m" specify column number (the most left column is column 1) at which annunciator to be turned on/off is placed.

When m = 0, all annunciators are turned on or off.

Once an annunciator(s) is turned on, it remains on until turned off by this command, the ESC@ or US@ command is executed, or the power is turned off.

[example]: To turn on the annunciator at the third column:

[n = 01h], [m = 03h]
 To turn off all the annunciators:
 [n = 00h], [m = 00h]

※ *Above commands relating decimal point, comma, semicolon, and annunciator may not be available due to hardware limit of display tube.*

4.1.3 UTC Standard Command Mode

Command	Hex	Function Description
BS	08	Back space
HT	09	Horizontal tab
LF	0A	Line feed
CR	0D	Carriage return
DC0 p	10 p	Move cursor to specified position, $0 \leq p \leq 39$ (Please refer Row Character Position Chart)
DC1	11	Over write display mode
DC2	12	Vertical scroll mode
DC3	13	Cursor on
DC4	14	Cursor off
ESC d	1B 64	Change to UTC enhanced mode
US	1F	Clear display

Row Character Position Chart (Decimal)

Row1	0	1	2	3	4	5	6	7	8	9	10	11	12	13	14	15	16	17	18	19
Row2	20	21	22	23	24	25	26	27	28	29	30	31	32	33	34	35	36	37	38	39

Row Character Position Chart (Hex)

Row1	00	01	02	03	04	05	06	07	08	09	0A	0B	0C	0D	0E	0F	10	11	12	13
Row2	14	15	16	17	18	19	1A	1B	1C	1D	1E	1F	20	21	22	23	24	25	26	27

4.1.4 UTC Enhance Command Mode

Command	Hex	Function Description
ESC u A..CR	1B 75 41 [data x 20] 0D	Upper line display
ESC u B..CR	1B 75 42 [data x 20] 0D	Bottom line display
ESC u D..CR	1B 75 44 [data x 45] 0D	Upper line message scroll continuously
ESC u E..CR	1B 75 45 hh ':' mm 0D	Set and display 24 hour time $0 \leq h, m \leq 9$
ESC u F..CR	1B 75 46 [data x 45] 0D	Upper line message scroll once pass
ESC u H..CR	1B 75 48 n m 0D	Change attention code $32 \leq n, m$ (Default attention code $n=1Bh, m=75h$)
ESC u 1..CR	1B 75 49 [data x 40] 0D	Two line display
ESC RS..CR	1B 0F 0D	Change to UTC standard mode

4.1.5 AEDEX Command Mode

Command	Hex	Function Description
! # 1..CR	21 23 31 [data x 20] 0D	Upper line display
! # 2..CR	21 23 32 [data x 20] 0D	Bottom line display
! # 4..CR	21 23 34 [data x 45] 0D	Upper line message scroll continuously
! # 5..CR	21 23 35 hh ':' mm 0D	Set and display 24 hour time $0 \leq h, m \leq 9$
! # 5 CR	21 23 35 0D	Display 24 hour time
! # 6..CR	21 23 36 [data x 45] 0D	Upper line message scroll once pass
! # 8..CR	21 23 38 n m 0D	Change attention code $32 \leq n, m$ (Default attention code $n="!", m="#"$)
! # 9..CR	21 23 39 [data x 40] 0D	Two line display

4.1.6 ADM788 Command Mode

Command	Hex	Function Description
CLR	0C	Clear display
CR	0D	Carriage return
SLE1	0E	Clear up line and move cursor to upper line left most end
SLE2	0F	Clear low line and move cursor to lower line left most end
DC0	10 n	Set period to upper line last n position $1 \leq n \leq 7$
DC1	11 n	Set line blinking n=1, upper line n=2, lower line
DC2	12 n	Clear line blinking n=1, upper line n=2, lower line
SF1	1E	Clear field 1 and move cursor to field 1 fast position
SF2	1F	Clear field 2 and move cursor to field 2 fast position

4.1.7 DSP800 Command Mode

Command	Hex	Function Description
EOT SOH I n ETB	04 01 49 n 17	Select international character set (Please refer <i>International Font Set Table</i>)
EOT SOH P n ETB	04 01 50 n 17	Move cursor to specified position $49 \leq n \leq 88$
EOT SOH C n m ETB	04 01 43 n m 17	Clear display range from <u>n</u> position to <u>m</u> position and move cursor to <u>n</u> position $49 \leq n \leq m \leq 88$
EOT SOH S n ETB	04 01 53 n 17	Save the current displaying data (40 characters) to n'th layer for demo display $1 \leq n \leq 3$ (n specify the layer 1, 2, or 3)
EOT SOH D n m ETB	04 01 44 n m 17	Display the saved data $1 \leq n \leq 3$ (n specify the layer 1, 2, or 3) "m" can be ignored
EOT SOH A n ETB	04 01 41 n 17	Brightness adjustment $1 \leq n \leq 4$
EOT SOH = n ETB	04 01 3D n 17	Select peripheral device n=1, printer ; n=2, display
EOT SOH % ETB	04 01 25 17	Initialize display

* International Font Set Table

n (Hex)	International Font Set
30h	U.S.A.
31h	FRANCE
32h	GERMANY
33h	U.K.
34h	DENMARK I
35h	SWEDEN
36h	ITALY
37h	SPAIN
38h	JAPAN
39h	NORWAY
3Ah	DENMARK II
XXh	SLAVONIC/RUSSIA
	RUSSIAN
	GREEK
	CZECH
	LATIVAIN

4.1.8 CD5220 Command Mode

Command	Hex	Function Description
ESC DC1	1B 11	Overwrite mode
ESC DC2	1B 12	Vertical scroll mode
ESC DC3	1B 13	Horizontal scroll mode
ESC Q A CR	1B 51 41 [N]20 0D	Set string display mode, write string to upper line
ESC Q B CR	1B 51 42 [N]20 0D	Set string display mode, write string to lower line
ESC Q D CR	1B 51 44 [N]m20 0D	Upper line message scroll continuously m<40
ESC [D	1B 5B 44	Move cursor left
BS	08	Move cursor left
ESC [C	1B 5B 43	Move cursor right
HT	09	Move cursor right
ESC [A	1B 5B 41	Move cursor up
ESC [B	1B 5B 42	Move cursor down
LF	0A	Move cursor down
ESD [H	1B 5B 48	Move cursor to home position
HOM	0B	Move cursor to home position
ESC [L	1B 5B 4C	Move cursor to left-most position
CR	0D	Move cursor to left-most position
ESC [R	1B 5B 52	Move cursor to right-most position
ESC [K	1B 5B 4B	Move cursor to bottom position
ESC I x y	1B 6C x y	Move cursor to specified position 1 ≤ x ≤ 20 (column) ; y=1,2 (row)
ESC @	1B 40	Initialize display
ESC W s x1 x2 y	1B 57 s x1 x2 y	Enable or disable the window range at horizontal scroll mode s=0,1 (disable, enable) 1 ≤ x1 ≤ x2 ≤ 20 (column) ; y=1,2 (row)
CLR	0C	Clear display screen, and clear string mode
CAN	18	Clear cursor line, and clear string mode
ESC * n	1B 2A n	Brightness adjustment 1 ≤ n ≤ 4
ESC & s n m [a(pl..p5)] (m-n+1)	1B 26 s n m [a(pl..p5)] (m-n+1)	Define download characters s=1 ; 32 ≤ n ≤ m ≤ 126 ; a=5 (p1..p5 = pattern1..pattern5)
ESC ? n	1B 3F n	Delete download characters 32 ≤ n ≤ 126 (n=character code)
ESC % n	1B 25 n	Select / cancel download character set. n=0, canceled ; n=1, selected
ESC _ n	1B 5F n	Set cursor ON/OFF n=0,1 (Off,On)
ESC f n	1B 66 n	Select international fonts set
ESC c n	1B 63 n	Select fonts, ASCII code or JIS code
ESC = n	1B 3D n	Select peripheral device n=1, printer ; n=2, display ; n=3, printer & display

(REMARK)

* While using command “ESC Q A” or “ESC Q B”, these two commands could be used combining with terminal printer - TP 2688 or TP3688

* If using command “ESC Q A” or “ESC Q B”, others commands can't be used except using command “CLR” or “CAN” to change operating mode.

* If using command “ESC Q D”, message on upper line will move continuously till receiving a new command, clearing upper line, and moving cursor to most left position on upper line.

*** International Font Set Table**

n (Decimal)	International Font Set
A	U.S.A
G	GERMANY
I	ITALY
J	JAPAN
U	U.K.
F	FRANCE
S	SPAIN
N	NORWAY
W	SWEDEN
D	DENMARK I
E	DENMARK II
L	SLAVONIC
R	RUSSIA
	Reserved

*** Select Code Table**

n (Decimal)	International Code
A	compliance with ASCII code
J	compliance with JIS code
R	compliance with RUSSIA code
L	compliance with SLAVONIC code

4.1.9 EMAX Command Mode

Command	Hex	Function Description
ESC DC1	1B 11	Overwrite mode
ESC DC2	1B 12	Vertical mode
ESC DC3	1B 13	Horizontal scroll mode
ESC [D	1B 5B 44	Move cursor left
BS	08	Move cursor left
ESC [C	1B 5B 43	Move cursor right
HT	09	Move cursor right
ESC [A	1B 5B 41	Move cursor up
ESC [B	1B 5B 42	Move cursor down
ESC [H	1B 5B 48	Move cursor to home position
HOM	0B	Move cursor to home position
ESC [L	1B 5B 4C	Move cursor to left-most position
CR	0D	Move cursor to left-most position
ESC [R	1B 5B 52	Move cursor to right-most position
ESC [K	1B 5B 4B	Move cursor to bottom position
ESC x y	1B 6C x y 1 ≤ x ≤ 20, y = 1,2	Move cursor to specified position
ESC @	1B 40	Initialize display
CLR	0C	Clear display screen, and clear string mode
CAN	18	Clear cursor line, and clear string mode
ESC * n	1B 2A n 1 ≤ n ≤ 4	Brightness mode
ESC _ n	1B 5F n n = 0,1	Set cursor ON/OFF
ESC f n	1B 66 n	Select international fonts
ESC c n	1B 63 n	Select fonts, ASCII code or JIS code
ESC = n	1B 3D	Select peripheral device, display or printer n = 1; enable printer, disable display n = 2; disable printer, enable display n = 3; enable printer, enable display

4.1.10 LOGIC Command Mode

Command	Hex	Function Description
^Q	11	Overwrite mode
^R	12	Vertical mode
^I	09	Horizontal tab
^H	08	Back space
^J	0A	Line feed
^M	0D	Carriage return
^S	13	Cursor on
^T	14	Cursor off
^P	10	Digital select e.g. 10 00 MSD of top row 10 13 LSD of top row 10 14 MSD of bottom row 10 27 LSD of bottom row
^	1F	Reset
^D n	04 n	Brightness mode 04 FF – 100% Brightness mode 04 60 – 60% Brightness mode 04 40 – 40% Brightness mode 04 20 – 20% Brightness mode

Chapter 5 Character Set

5.1 U.S.A. / Standard Character Set (20h - 7Eh)

	0	1	2	3	4	5	6	7	8	9	A	B	C	D	E	F
20h		!	“	#	\$	%	&	'	()	*	+	,	-	.	/
30h	0	1	2	3	4	5	6	7	8	9	:	;	<	=	>	?
40h	@	A	B	C	D	E	F	G	H	I	J	K	L	M	N	O
50h	P	Q	R	S	T	U	V	W	X	Y	Z	[\]	^	_
60h	`	a	b	c	d	e	f	g	h	i	j	k	l	m	n	o
70h	p	q	r	s	t	u	v	w	x	y	z	{		}	~	

5.2 International Character Selection

No.	International	23	24	40	5B	5C	5D	5E	60	7B	7C	7D	7E
	U.S.A.	#	\$	@	[\]	^	`	{		}	~
1	FRANCE	#	\$	à	°	Ç	§	^	`	é	ù	è	¨
2	GERMANY	#	\$	§	Ä	Ö	Ü	^	`	ä	ö	ü	ß
3	U.K.	£	\$	@	[\]	^	`	{		}	~
4	DENMARK I	#	\$	@	Æ	Φ	Â	^	`	æ	ø	â	~
5	SWEDEN	#	¤	É	Ä	Ö	Å	Ü	é	ä	ö	å	ü
6	ITALY	#	\$	@	°	\	é	^	ù	à	ò	è	ì
7	SPAIN	₧	\$	@	ı	Ñ	ı	^	`	¨	ñ	}	~
8	JAPAN	#	\$	@	[¥]	^	`	{		}	~
9	NORWAY	#	¤	É	Æ	Ø	Å	Ü	é	æ	ø	å	ü
10	DENMARK II	#	\$	É	Æ	Ø	Å	Ü	é	æ	ø	å	ü
11	SLAVONIC	#	\$	@	[\]	^	`	{		}	~
12	RUSSIA	#	\$	@	[\]	^	`	{		}	~

5.3 Character Code Table









5.3.1 Page 0 (PC437: U.S.A., Standard Europe)

00h – 7Fh









	00h	10h	20h	30h	40h	50h	60h	70h
0				0	@	P	`	p
1			!	1	A	Q	a	q
2			"	2	B	R	b	r
3			#	3	C	S	c	s
4			\$	4	D	T	d	t
5			%	5	E	U	e	u
6			&	6	F	V	f	v
7			'	7	G	W	g	w
8			(8	H	X	h	x
9)	9	I	Y	i	y
A			*	:	@	Z	j	z
B			+	;	A	[k	{
C			,	<	B	\	l	
D			-	=	C]	m	}
E			.	>	D	^	n	~
F			/	?	E	_	o	

To be continued on next page...

80h – FFh

	80h	90h	A0h	B0h	C0h	D0h	E0h	F0h
0	Ç	Ê	á		└	┘	α	≡
1	ü	æ	í		┘	└	β	±
2	é	Æ	ó		└	└	Γ	≧
3	â	ô	ú		┘	└	π	≦
4	ä	ö	ñ	┘	—	└	Σ	
5	à	ò	N	┘	+	└	σ	
6	å	û	ã	┘	┘	└	μ	÷
7	ç	ù	◌̇	└	┘	+	τ	≈
8	ê	ÿ	ı	└	└	+	Φ	°
9	ë	Ï	└	┘	└	└	⊖	.
A	è	Û	└		┘	└	Ω	.
B	ï	ç	½	└	└		δ	√
C	î	£	¼	┘	┘		∞	n
D	ì	¥	ı	┘	—		φ	2
E	Ä	Pts	«	┘	+		ε	
F	À		»	└	┘		∩	

5.3.2 Page 1 (PC863: Canadian-French)

	80h	90h	A0h	B0h	C0h	D0h	E0h	F0h
0	Ç	È	Ì		└	┘	α	≡
1	ü	É	˘		┘	└	β	±
2	é	Ê	Ó		┘	┘	Γ	≧
3	â	Ô	Ú		┘	└	π	≦
4	À	Ë	˙	┘	—	└	Σ	
5	à	Ï	¸	┘	+	└	σ	
6	¶	û	³	┘	┘	└	μ	÷
7	ç	ù	˘	└	┘	+	τ	≈
8	ê	æ	Î	└	└	+	Φ	°
9	ë	Ï	└	┘	└	└	⊗	.
A	è	Û	└		┘	└	Ω	.
B	ï	¢	½	└	┘		δ	√
C	î	£	¼	└	┘		∞	n
D	—	Ü	¾	└	—		φ	²
E	À	Û	«	└	+		ε	
F	§		»	└	┘		∩	

5.3.3 Page 2 (Japanese Katakana)

	80h	90h	A0h	B0h	C0h	D0h	E0h	F0h
0	■	■		■	タ	ミ	□	日
1	■	■	.	ア	チ	ム	■	月
2	■	■	「	イ	ツ	メ	■	火
3	■	■	」	ウ	テ	モ	○	水
4	■	■	、	エ	ト	ヤ	●	木
5	■	■	.	オ	ナ	ユ	◇	金
6	■	■	ヲ	カ	ニ	ヨ	◆	土
7	■	→	フ	キ	ヌ	ラ	◆	年
8	■	←	イ	ク	ネ	リ	▶	円
9	■	↑	ウ	ケ	ノ	ル	◀	分
A	■	↓	エ	コ	ハ	レ	▲	人
B	■	×	オ	サ	ヒ	ロ	▼	大
C	■	÷	ヤ	ツ	フ	ワ	《	中
D	■	±	ユ	ス	ヘ	ン	》	小
E	■	≤	■	セ	ホ	“	½	〒
F	■	≥	ツ	ソ	マ	°	¼	℃

Chapter 6 Appearance

